

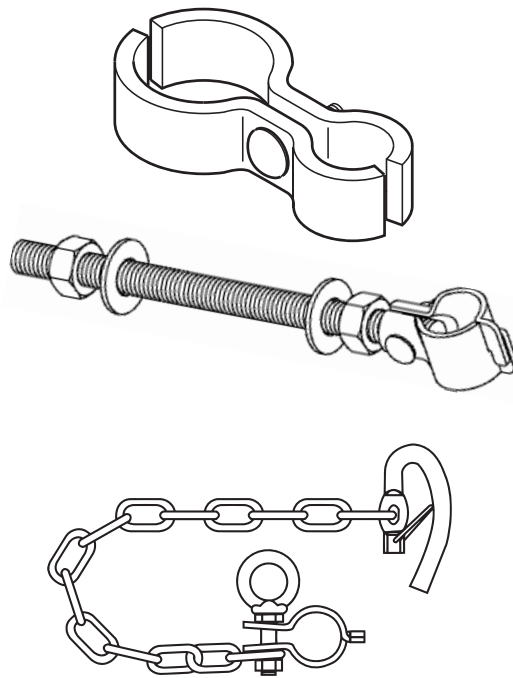

The Innovators.®. do it.®

1300 4 VATER



ELGATE RURAL PRODUCTS
-TRADE INFO GUIDE-

Rural Farm Gate Fittings

NEW FROM ELGATE RURAL



SCREW / WELD CHAIN LATCH



CODE	CTN	ZINC / GALV	KG
SWHCLZ (ZINC)	50		21
SWHCLG (GALV)	50		21

GATE HINGE 80X32



CODE	CTN	GALVANISED	KG
GH8032	14		15

GATE CHAINS & LATCHES

RING CHAIN



Screw In Chain & Screw In Knob

CODE	CTN	GALVANISED	KG
PKCL35012	40		19

RING CHAIN - ATTACHED



Bolt Through Knob & Attached Chain

CODE	CTN	GALVANISED	KG
PKCL35012AB	40		15

HOOK & CHAIN



Screw In Ring & Hook with Chain Latch

CODE	CTN	GALVANISED	KG
HCLR400	50		22

HOOK & CHAIN + STAPLES



Hook & Chain Latch with 2 Staples

CODE	CTN	GALVANISED	KG
HCLS400	50		25

HOOK & CHAIN ONLY



Hook & Chain Latch Only

CODE	CTN	GALVANISED	KG
HCLS500	60		23

DOUBLE GATE



Bolt On Double Gate Latch

CODE	CTN	GALVANISED	KG
DGCL	40		28

GATE BOW



CODE	CTN	GALVANISED	KG
GB20	20		15
GB25	20		16

TWO WAY CATCH



CODE	CTN	ZINC	KG
TWC20	50		21
TWC25	40		25
TWC32	40		25

HINGE STRAPS - BOLT THROUGH

ADJUSTABLE



CODE	CTN	GALVANISED	KG
ABTHS35025GALV	25		22
ABTHS45025GALV	25		25
ABTHS45032GALV	25		23

TOP STRAPS - BOLT THROUGH



CODE	CTN	GALVANISED	KG
TS270	16		16

LONG PIN GUDGEONS

SCREW IN



CODE	CTN	GALVANISED	KG
LPSG20	80		20
LPSG25	40		22

ADJUSTABLE



CODE	CTN	GALVANISED	KG
LPG35025	30		26

ANTI TWIST



CODE	CTN	KG
ATG27525	20	22
ATG40025	16	21
ATG40032	20	23

STEEL



CODE	CTN	GALVANISED / ZINC	KG
BG270	30		24
RBG25*	30		24
RG25* *ZINC	30		14

BOLT ON



CODE	CTN	KG
BS25	40	19

GATE GUDGEONS

LONG PLATE BOLT ON



CODE	CTN	GALVANISED	KG
LBG20	60		20
LBG25	60		22
LBG27	60		24
LBP	100		24

CHANNEL - WELD



CODE	CTN	GALVANISED	KG
CG20	100		20
CG25	100		23
CG27	100		26

ANGLE



CODE	CTN	GALVANISED	KG
AG20	100		23
AG25	80		21
AG27	80		24
AG33	40		23

BOLT ON



CODE	CTN	GALVANISED	KG
BG20	80		20
BG25	80		22
BG27	80		24
BG33	40		24

2 PIECE COLLAR & BOLT HINGE



CODE	PACK	GALVANISED	KG
RCB45025	20		27

HINGE STRAPS



CODE	CTN	GALVANISED	KG
RAPS25	50		17
RAPS32	50		20

ANGLE POST GUDGEON



CODE	CTN	GALVANISED	KG
RAPG25	40		20
RAPG27	40		21

BOLT ON



CODE	CTN	ZINC	KG
TS25	60		17

LOOSE FIT



CODE	CTN	GALVANISED	KG
HSLF20	200		18
HSLF25LD	120		19
HSLF25HD	70		21
HSLF32	60		21
HSLF40	60		21

STRAP ATTACHMENT



CODE	CTN	GALVANISED	KG
SA1	400		22
SA2	300		17
SA3HD	150		12
SA4HD	150		15

BACK PLATE



CODE	CTN	GALVANISED	KG
BP1	300		16
BP2	200		20
BP3	100		20
BP4	100		21

WELD ON HINGE + SOCKET

Available in twin packs (4 hinges) add '2PK' to end of code



CODE	CTN	ZINC PLATED	KG
WSWP12BZ (100KG)	120		14
WSWP16BZ (175KG)	70		22
WSWP20BZ (300KG)	30		23
WSWP27BZ (350KG)	16		25

TWO PART HINGE WITH ATTACHMENTS



CODE	CTN	GALVANISED	KG
TH4025	32		18
TH4032	32		24
TH5025	32		20
TH5032	32		25
TH6525	24		22
TH6532	24		24



CODE	CTN	KG
SH8025	24	21
SH8032	24	22
SH8040	24	23
SH10025	24	24
SH10032	24	25
SH10040	24	26



CODE	CTN	KG
HA25	200	18
HA32	150	16
HA40	100	12

Leaders in Innovation, Design, Testing & Production in Australia for over 30 years.

TWO PART HINGE ATTACHMENTS

SELF CLOSE GALVANISED

CODE	CTN	KG
HP25SC	20	11

FIXED GALVANISED

CODE	CTN	KG
HAP20	60	12
HAP25	40	9

ADJUSTABLE GALVANISED

CODE	CTN	KG
HAPA20	60	13
HAPA25	60	15

LONG PIN GALVANISED

CODE	CTN	KG
HALPA25	40	14
HALPA32	40	15

STRAINER ASSEMBLY

•Patent •Registered Design

GALVANISED

CODE	CTN	KG
FT80	40	15
FT100	30	13

FB40	50	23
FB50	40	23

GALVANISED

CODE	CTN	KG
AAT10040	10	20

HINGES & CLAMPS

STOCK YARD

GALVANISED

CODE	CTN	KG
SYH3220	32	22
SYH4025	32	26
SYH5025	24	21
SYH5032	24	22

GALVANISED

CODE	CTN	KG
SYC3232	32	22
SYC4025	32	22
SYC5025	32	24
SYC5032	32	25
SYC5050	24	23
SYC8025	16	16
SYC8032	16	16

CATTLE YARD

GALVANISED

CODE	CTN	KG
CYH5025	16	25
CYH8032	12	22

GALVANISED

CODE	CTN	KG
CYC4040	50	22
CYC5050	12	19
CYC8050	12	20
CYC10050	12	24

DOUBLE HINGES

GALVANISED

CODE	CTN	KG
DH2020	60	23
DH2525	50	23
DH3220	60	29

TEMPORARY

GALVANISED

CODE	CTN	KG
DH2525	50	23
CYC4040	50	22

CATTLE YARD RAIL COMPONENTS

GALV & PCB AVAILABLE. ADD TO END OF CODE. SUITS 115x42mm OVAL RAIL

RAIL JOINER

ZINC PLATED

• A	CODE	CTN	KG
	VRH115	30	13

RAIL END JOINER

ZINC PLATED

• B	CODE	CTN	KG
	VRH115EJ	30	18

RAIL CLIP

ZINC PLATED

• C	CODE	CTN	KG
	VRH115CLIP	60	13

RAIL HANGER SGL / DBL END

ZINC PLATED

• D & E	CODE	CTN	KG
	VCATTLECRH	48	18
	VCATTLECR	24	19

CAP - GALV / PLASTIC

ZINC PLATED

• F	CODE	CTN	KG
	VRH115C	50	5
	VACEPC01154* *PLASTIC	125	5

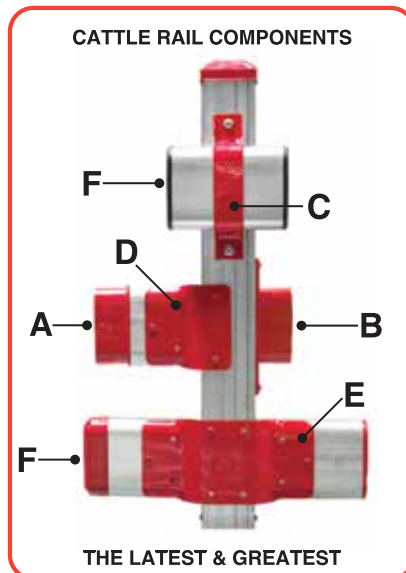

PANEL PIN & CLEATS

ZINC

CODE	CTN	KG
PPHC	100	14
PPFC	50	14
PP275	30	16

CHAIN MESH FENCE FIXINGS

CLIP

GALVABOND

CODE	CTN	KG
MB	1500	19

BRACKET

GALVANISED

CODE	CTN	KG
MC	1500	15

MESH CLIP PACKS

GALVABOND

CODE	CTN	KG
FITSTEK20P	25	11
FITSTEK20B* *PCB	25	11

20 pack

SPIGOTS - CHAIN MESH CAGES

TEE

GALVANISED

CODE	CTN	KG
T3240SPIGOT	20	14
T4032SPIGOT	20	14

CROSS

GALVANISED

CODE	CTN	KG
X3240SPIGOT	20	14

INTERNAL PIPE JOINERS

Extra Light to Medium Wall

GALVANISED

CODE	CTN	KG
IPS25	70	20
IPS25M	90	23
IPS32	50	18
IPS32M	50	17
IPS40	36	17
IPS40M	36	17
IPS50	18	12
IPS50M	18	12

POST CAPS - WORLD LEADERS

GALVABOND

ROUND	CODE	CTN	KG
	PC20	500	9
	PC25	450	16
	PC32	300	17
	PC40	240	19
	PC50	150	15
	PC65	100	13
	PC80	60	10
	PC90	50	11
	PC100	40	10
	PC125	24	9
	PC150	15	7
	PC220	10	8

SQUARE

GALVABOND

CODE	CTN	KG
SPC25	500	9
SPC35	540	17
SPC40	500	19
SPC50	270	16
SPC65	200	18
SPC75	120	21
SPC90	80	13
SPC90F	80	12
SPC100	60	12
SPC100F	80	16
SPC125	30	7
SPC125F	30	7
SPC150	30	10

PLASTIC CAPS

ROUND INTERNAL - nominal bore

CODE	CTN	KG
PCR25NB	600	4
PCR32NB	250	3
PCR40NB	200	3
PCR50NB	150	3

ROUND INTERNAL - tube dimensions

CODE	CTN	KG
PCR16	1500	2
PCR19	1250	3
PCR25	800	3

SQUARE INTERNAL - tube dimensions

CODE	CTN	KG
PCF20	1000	2
PCF25	400	2
PCF30	400	2
PCF35	200	2
PCF40	400	4
PCF50	200	3
PCF65	100	3
PCF75	80	3
PCF90	50	3
PCF100	40	3
PCF125	30	3
PCF150	20	4

RECTANGLE INTERNAL - tube dimensions

CODE	CTN	KG
HARDSCP3557P	300	4
PCF3825	600	4
PCF5025	450	4
RPC6516SLIT	500	4
PCF6535	200	3
PCF7525	200	3
PCF7550	150	3
PCF7638	150	3
PCF10050	80	3
PCF12575	50	3
PCF15050	70	5
PCF150100	30	5

SQUARE TUBE CAP - tube dimensions

CODE	CTN	KG
PCD50	50	3
PCD60	50	2
PCD65	50	2

FLAT PLUG - hole dimensions

CODE	CTN	KG
PCRD16	1500	3
PCRD19	1000	2
PCRD25	500	2

GALVANISED CHAIN

CODE	TUB	MTR*	KG
CHAING6X25	1	30.0	25
CHAING6X50	1	60.0	50
CHAING8X25	1	18.5	25
CHAING8X50	1	37.0	50
CHAING10X50	1	23.5	50
CHAING12X50	1	13.5	50

*Approx length only

CHAIN CATCHES

CODE	CTN	KG
CC6Z 6mm	200	21
CC8Z 8mm	60	22

HAND TOOLS & ACCESSORIES

WELD ON WIRE RESTRAINER

CODE	CTN	KG
WWRZ10	300	18

WIRE JOINER TOOL

CODE	CTN	KG
FTST-SEMI	1	.91

PERMANENT WIRE STRAINER

CODE	CTN	KG
PWS	1	.18

CHAIN WIRE STRAINER

CODE	CTN	KG
CWS	1	4

CHAIN WIRE STRAINER - HEAVY DUTY

CODE	CTN	KG
CWSHD	1	4

WIRE JOINERS

CODE	CTN	KG
FTST-1	300	6
1.8mm - 3mm - END		
FTST-2	150	7
1.8mm - 3mm		
FTST-4	150	8
2.7mm - 4mm		

STAPLES

CODE	TUB	KG
STAPLES505KG	1	5

TURN BUCKLES

CODE	CTN	KG
EYE-HOOK		
TURNMETB10	50	15
TURNMETB12	40	21
EYE-EYE		
TURN324208	50	7
TURN324210	50	15
TURN324212	40	21

SPRING COIL

CODE	CTN	KG
360MM + SCREWS		
G305SC	1	0.7

SLAM CATCH - WELD

CODE	CTN	KG
SCL (left)	10	26
SCR (right)	10	26
SCM (multi)	10	26
SCMUH (U handle)	6	21

D-HANDLE SLAM CATCH

CODE	CTN	KG
FSCJ14 14mm	25	22
SLAM20 20mm	8	15

SLAM CATCH STRIKE PLATE

CODE	CTN	KG
SST14 14mm striker	200	30
SST20 20mm striker	80	25
SST25 25mm striker	80	25
SST825 25x8mm striker	70	19

FARM GATE SOLAR AUTOMATION

CODE	KIT	KG
FARMGATESOLAR	1	22.1
H071240ZKIT1SOL	1	30.0

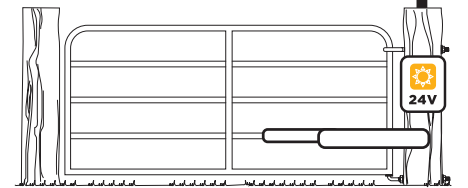

ALL KITS INCLUDES:

- 1 x SWING GATE OPERATOR
- 1 x CONTROL PANEL
- 1 x SOLAR PANEL (WITH MOUNTING BRACKET)
- 1 x BATTERIES & HOUSING
- 2 x REMOTES

24V MOTOR	 SOLAR	 MAGNETIC BATTERIES LIMITS INCLUDED	4.0M MAX LENGTH	500KG MAX WEIGHT
---------------------	-----------	---	---------------------------	----------------------------

(Maximum gate length and weights may vary)

CASTOR WHEELS

125MM RED CASTOR WHEEL

CODE	CTN	KG
REDCASTORS5 SWIVEL	1	3.10
REDCASTORF5 FIXED	1	2.45
REDCASTORSB5 SWIVEL WITH BRAKE	1	3.10

GATE WHEEL 4" & 5" SWIVEL + SPRING LOADED

CODE	CTN	KG
GCASTORS MAX CAP 57KG - 100MM	1	0.90
GCASTORLGE MAX CAP 100KG - 125MM	1	3.00

BOLTS, LOCKS & STOPS

PAD BOLTS

CODE	CTN	KG
EPB100 4" (100MM)	50	5.20
EPB150 6" (150MM)	30	10.7

PANIC / SPRING PAD BOLT

CODE	CTN	KG
G800 PADBOLT & KEEPER	50	5.20
CX01A SPRING PADBOLT LATCH ONLY	30	10.7

HASP & STAPLE

CODE	CTN	KG
G58HANDS 235mm	1	0.60

STEEL SCROLLS

CODE	CTN	KG
SC230 230mm x 5mm	1	.34
SC270 270mm x 5mm	1	.30

STEEL RINGS

CODE	CTN	KG
R82	100	9
R90	100	10
R100	100	17

Gate Packs - *Others Available On Request*

FGP189G

275 x 25NB - Anti Twist Pack

PASSIVATED GOLD

CTN	KG
10	24

Contains:

- 1 X ATG27525
- 1 X ABTHS35025
- 1 X HCLS400

FGP189HDG

275 x 25NB - Anti Twist Pack

HOT DIP GALV

CTN	KG
10	24

Contains:

- 1 X ATG27525
- 1 X ABTHS35025
- 1 X HCLS400

FGP1HCR

GALVANISED

25NB - Farm Pack 25NB

CTN	KG
12	18

Contains:

- 1 X LPSG25
- 1 X ABTHS35025
- 1 X HCLR400
- 1 X Coach Screw

FGP3SELGATE

GALVANISED

25NB - Gate Pack 3 with Latch & Staples

CTN	KG
20	28

Contains:

- 1 X LBG25
- 1 X HSLF25HD
- 1 X SA3HD
- 1 X HCLS400
- 4 X Coach Screw

FGP8ELGATE

GALVANISED

350 x 25NB - Double Gate Pack

CTN	KG
5	20

Contains:

- 2 X LPG35025
- 2 X ABTHS35025GALV
- 1 X DGCL

FGP30A

GALVANISED

100 x 25NB - Round Post Pack

CTN	KG
10	23

Contains:

- 2 X SH10025
- 1 X HAP25
- 1 X K100

FGPES1

ZINC PLATED

25NB - Bolt On Pack

CTN	KG
15	23

Contains:

- 1 X BS25
- 1 X TS25
- 1 X GL1
- 1 X LR12
- 4 X Coach Screw
- 1 X Coach Screw

FGP191G

400 x 25NB - Anti Twist Pack

PASSIVATED GOLD

CTN	KG
8	27

Contains:

- 1 X ATG40025
- 1 X ABTHS45025
- 1 X HCLS400

FGP191HDG

400 x 25NB - Anti Twist Pack

HOT DIP GALV

CTN	KG
8	27

Contains:

- 1 X ATG40025
- 1 X ABTHS45025
- 1 X HCLS400

FGP2ELGATE

GALVANISED

25NB - Gate Pack 2

CTN	KG
10	16

Contains:

- 1 X LPSG25
- 1 X HSLF25HD
- 1 X PKCL35012
- 2 X Coach Screw

FGP4HCR

GALVANISED

350 x 25NB - Gate Pack 4

CTN	KG
10	20

Contains:

- 1 X LPG35025
- 1 X ABTHS35025
- 1 X HCLR400
- 1 X Coach Screw

FGP20

GALVANISED

450 x 25NB - Rural Collar Pack

CTN	KG
8	32

Contains:

- 2 X RCB45025
- 1 X PKCL35012

FGP30B

GALVANISED

80 x 25NB - Round Post Pack

CTN	KG
10	23

Contains:

- 2 X SH8025
- 1 X HAP25
- 1 X K80

FGPSP1

ZINC PLATED

25NB - Bolt Through Pack

CTN	KG
10	22

Contains:

- 1 X RBG25
- 1 X TG25
- 1 X GL1
- 1 X LR12
- 1 X Coach Screw

FGP195G

400 x 32NB - Anti Twist Pack

PASSIVATED GOLD

CTN	KG
6	18

Contains:

- 1 X ATG40032
- 1 X ABTHS45032
- 1 X HCLS400

FGP195HDG

400 x 32NB - Anti Twist Pack

HOT DIP GALV

CTN	KG
6	18

Contains:

- 1 X ATG40032
- 1 X ABTHS45032
- 1 X HCLS400

FGP3ELGATE

GALVANISED

25NB - Gate Pack 3

CTN	KG
10	14

Contains:

- 1 X LBG25
- 1 X HSLF25HD
- 1 X SA3HD
- 1 X PKCL35012
- 4 X Coach Screw

FGP7ELGATE

GALVANISED

25NB - Gate Pack 7

CTN	KG
10	16

Contains:

- 1 X RAPS25
- 1 X RAPG25
- 1 X PKCL35012AB
- 4 X Zinc Hex Bolts M12x30

FGP270

GALVANISED

270 x 25NB - Top Saddle Pack

CTN	KG
8	20

Contains:

- 1 X BG270
- 1 X TS270
- 1 X HCLS500
- 1 X Coach Screw

FGPEG1

ZINC PLATED

25NB - Screw In Pack

CTN	KG
15	21

Contains:

- 1 X RG25
- 1 X TS25
- 1 X GL1
- 1 X LR12
- 1 X Coach Screw
- 2 X Coach Screw

FGPTB1

ZINC PLATED

25NB - Screw/Bolt Through Pack















CTN	KG
10	19

Contains:

- 1 X RG25
- 1 X TG25
- 1 X GL1
- 1 X LR12
- 1 X Coach Screw

CATALOGUE RANGE

WWW.VATERHARDWARE.COM

	ELTRAK SLIDING DOOR SYSTEMS CATALOGUE	30pg
	ELTRAK TOP HUNG DOOR SYSTEMS	16pg
	ELTRAK BOTTOM ROLLER DOOR SYSTEMS	12pg
	ELTRAK SLIDING DOOR SYSTEMS PRICE LIST	6pg
	ELGATE SECURITY FENCE & GATE SYSTEMS CATALOGUE	48pg
	ELGATE FENCE & GATE SYSTEMS PRICE LIST	6pg
	ELGATE RURAL FARM & GATE SYSTEMS	6pg
	ELGATE SLIDING GATE HARDWARE	6pg
	VATER SAFETY RAIL & BARRIER FITTINGS	6pg
	VATER GATE AUTOMATION SYSTEMS	6pg
	VATER CANTILEVER GATE SYSTEMS	6pg
	VATER HARDWARE & ACCESSORIES	6pg
	VATER D&D POOL LOCKS & GATE HARDWARE	44pg
	WATCH THIS SPACE! EXCITING NEW PRODUCT RELEASES!	

ADELAIDE

Vater Hardware
28-32 Morgan Street
Wingfield, SA 5013
Tel: +61 8 8268 3511
Fax: +61 8 8445 7470
adelaide@vaterhardware.com

SYDNEY

Vater Hardware
2/78 Heathcote Road
Moorebank, NSW 2170
Tel: +61 2 8777 0777
Fax: +61 2 8777 0778
sydney@vaterhardware.com

BRISBANE

Vater Hardware
2/388 Newman Road
Geebung, QLD 4034
Tel: +61 7 3265 7888
Fax: +61 7 3265 7688
brisbane@vaterhardware.com

MELBOURNE

Vater Hardware
18-24 Pelson Court
Dandenong Sth, VIC 3175
Tel: +61 3 8902 8800
Fax: +61 3 8902 8898
melbourne@vaterhardware.com

PERTH

Vater Hardware
56 O'Malley Street
Osborne Park, WA 6017
Tel: +61 8 9492 8444
Fax: +61 8 9244 5635
perth@vaterhardware.com